











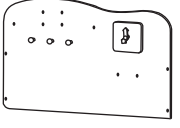







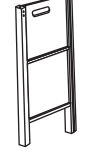

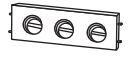
Bandits and Angels

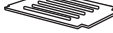
Houten keuken | Montage handleiding
 Wooden kitchen | Assembly instructions
 Hölz Küche | Anleitung
 La cuisine en bois | Notice de montage
 Cucina in legno | Le istruzioni per l'assemblaggio
 Cocina de madera | Las instrucciones para el montaje



Art. SB2200 / SB2211

INHOUD / CONTENT / INHALT / CONTENU / CONTENUTO / CONTENIDO

A  x 1	B  x 1	C  x 1	D  x 1
E  x 1	F  x 1	G  x 1	H  x 1
I  x 1	J  x 1	K  x 1	L  x 1
M  x 1	N  x 1	O  x 1	P  x 1
Q  x 1	R  x 1	S  x 2	 V x 6PCS  W x 6PCS  X x 22PCS  Y x 1PC

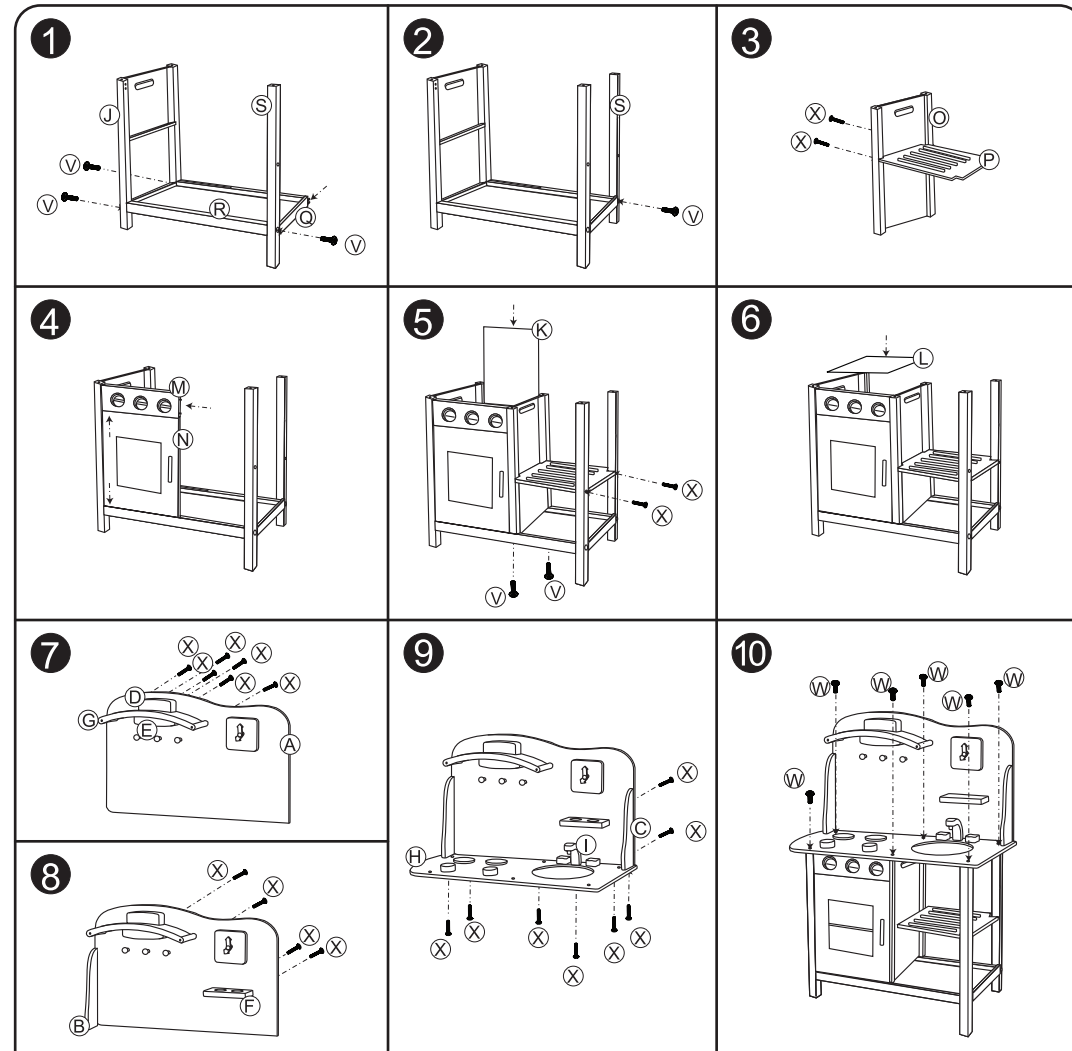
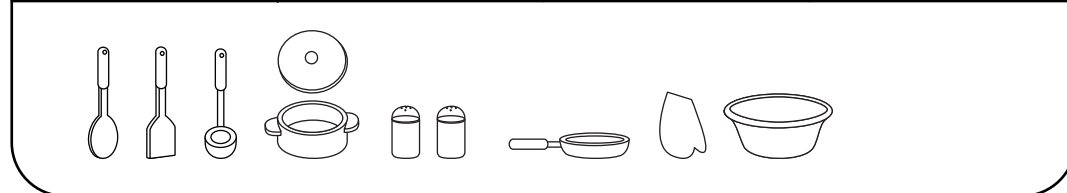

NL
 Waarschuwing! Niet geschikt voor kinderen onder de 3 jaar. Kleine onderdelen. Verstikkingsgevaar. Montage van het voorwerp dient door een volwassene te gebeuren. Verwijder alle verpakkingsmateriaal alvorens het speelgoed aan uw kind te geven. De details en de kleuren van de inhoud kunnen verschillen. Informatie graag bewaren.

D
 Warnung! nicht für kinder unter 3 Jahren geeignet. Kleinteile. Erstickungsgefahr. Das Produkt muss von einem Erwachsenen zusammengebaut werden. Entfernen sie das gesamte Verpackungsmaterial, bevor Sie das Spielzeug Ihrem Kind geben. Die Ausführungen und Farben des Inhalts können variieren. Bitte Aufschrift für ruckfragen aufbewahren.

GB
 Warning! Not suitable for children under 3 years. Small parts. Choking hazard. Item ist to be assembled by an adult. Remove all packaging matetials before giving the toy to your child. The details and colours of the contents can vary. Keep these instructions for future reference.

F
 Attention! Ne convient pas aux enfants de moins de 3 ans. Petites pieces. Danger d'étouffement. Montage de l'article à effectuer par un adulte. Retirer tous les emballages avant de donner je jouet à votre enfants. Les détails et coloris du contenu pauvent varier. Informations à conserver.

IT
 Attenzione! Non adatto a bambini sotto i 3 anni. Componenti di piccole dimensioni. Pericolo di soffocamento. Il montaggio deve essere effettuato da un adulto. Eliminare tutto il materiale da imballaggio prima di dare il giocattolo al bambino. I dettagli e i colori del contenuto possono variare. Si prega di conservare queste informazioni.

ESP
 Advertencia! No apto para niños menores de 3 años. piezas pequeñas. Peligro de asfixia. El montaje debe ser realizado por un adulto. Retire todo el embalaje antes de dar el juguete al niño. Los detalles y los colores pueden ser diferentes de los contenidos. Por favor guarde las instrucciones.

IMP: Dutch Bandits B.V., Jansstraat 69, 2011 RV HAARLEM - www.dutchbandits.com

